



# ART COOL PREMIER WALL MOUNTED OWNER'S MANUAL



Art Cool Premier Wall Mounted  
3/4 Ton and 1 Ton

# **PROPRIETARY DATA NOTICE**

**This document, as well as all reports, illustrations, data, information, and other materials is the property of LG Electronics U.S.A., Inc., and are disclosed by LG Electronics U.S.A., Inc., only in confidence.**

**This document is for design purposes only.**

DFS-OL-AG-001-US\_014C07



For continual product development, LG Electronics U.S.A., Inc., reserves the right to change specifications without notice.

©LG Electronics U.S.A., Inc.

# TABLE OF CONTENTS

<b>SAFETY INSTRUCTIONS</b> .....	<b>4-6</b>	<b>Advanced Functions</b> .....	<b>14-16</b>
<b>UNIT PARTS</b> .....	<b>7</b>	<i>Jet Cool/Heat Operation</i>	
<b>UNIT OPERATION</b> .....	<b>8-11</b>	<i>Auto Clean Operation</i>	
<i>Single Zone Art Cool Premier</i>		<i>Artificial Intelligence</i>	
<i>Remote Control</i>		<i>Auto Changeover Operation</i>	
<b>Basic Functions</b> .....	<b>12-13</b>	<i>Energy Saving Operation</i>	
<i>Cooling and Heating Operation</i>		<i>Manual Operation</i>	
<i>Timer Setting Functionality</i>		<b>MAINTENANCE</b> .....	<b>17-18</b>
		<b>TROUBLESHOOTING</b> .....	<b>19-22</b>

## TABLE OF SYMBOLS

 <b>WARNING</b>	<i>This symbol indicates a potentially hazardous situation which, if not avoided, may result in death or serious injury.</i>
<b>Note</b>	<i>This symbol indicates additional helpful information such as an explanation, a comment, or a clarification about the subject.</i>
	<i>This symbol indicates a recommendation or tip. Recommendations instruct the user to apply the suggested practice to ensure the best operating results in order to achieve the maximum benefit of the product. Tips contain practical information that may help the user solve a problem or describe actions that may save time.</i>

# SAFETY INSTRUCTIONS

## Single Zone Art Cool Premier

---

---

### IMPORTANT!

- Please read this manual completely before operation of the product.
- Follow the instructions in this manual to prevent product malfunction, property damage, injury or death to the user or other people. Incorrect operation due to ignoring any instructions will cause harm or damage.
- The level of seriousness is classified by the symbols described below.

#### **WARNING**

This symbol indicates a potentially hazardous situation which, if not avoided, may result in death or serious injury.

#### **Note:**

This symbol indicates additional helpful information such as an explanation, a comment, or a clarification about the subject.



This symbol indicates a tip or recommendation.

Recommendations instruct the user to apply the suggested practice to ensure the best operating results in order to achieve the maximum benefit of the product.

Tips contain practical information that may help the user solve a problem or describe actions that may save time.

---

### General Safety

#### **WARNING**

- Installation and repair must always be done by a qualified technician.
- Installation **MUST** conform with local building codes or, in the absence of local codes, with the Nation Electrical Code NFPA 70/ANSI C1-1003 or current edition and Canadian Electrical Code Part1 CSA C.22.1.
- Failure to carefully read and follow all instructions in this manual may result in equipment malfunction, property damage, personal injury and/or death.

---

### Power and Electrical Safety

#### **WARNING**

- Immediately disconnect the product in the event of a blackout or thunderstorm. Failure to do so may result in fire, electric shock and/or damage.
- Always insure proper equipment ground. Failure to do so may result in electric shock and/or product failure.
- Be sure a circuit breaker is installed before using the air conditioner. Failure to do so may result in electric shock and/or product failure.
- Do not connect the ground wire to a gas pipe, a lightning rod or a telephone ground wire; because it may result in electric shock and/or product failure.
- Use a standard circuit breaker and fuse conforming to the rating of the air conditioner. Failure to do so may result in electric shock and/or product failure.
- Do not modify or extend the power cable; because it may result in electric shock and/or fire. If the power cable shows wear, such as scratches or outer skin peeling off or deteriorated, then it must be replaced.
- Do not use a damaged power cord; because it may result in electric shock and/or fire.
- Do not touch, operate or repair the air conditioner with wet hands.; because it may result in electric shock or product failure.
- Do not place a heater or other heat generating appliances near the power cable; because it may result in electric shock and/or fire.
- Check that the power cord is not pulled or damaged while the air conditioner is operating. Failure to do so may result in electric shock, electric shock and/or fire.
- Do not place any objects on the power cord; because it may result in electric shock or product failure.

# SAFETY INSTRUCTIONS

## Single Zone Art Cool Premier

### Installation Safety Instructions

#### **⚠ WARNING**

- Do not install the air conditioners on an unstable surface or where there is a danger of it falling; because it may result in death, serious injury, and/or product failure.
- Contact an authorized service center when you install or relocate the air conditioner. Failure to do so may result in serious injury and/or product failure.
- Indoor/outdoor wiring connections must be secured tightly and the cable should be routed properly so that there is no force pulling the cable from the connection terminals. Improper or loose connections may cause heat generation or fire.
- Install the panel and the cover of the control box safely. Failure to do so may result in explosion or fire.
- Do not install the air conditioner near a place with a danger of explosion or fire; because it may result in explosion or fire which may result in serious bodily injury or death.
- Ensure that the pipe and the power cable which connect the indoor unit and the outdoor unit are not pulled tight when installing the air conditioner. Failure to do so may result in electric shock or product failure.
- Do not mix air or gas in the system except for the specific refrigerant. If air enters the refrigerant system, it may result in excessively high pressure that may lead to personal injury or damage to the equipment.
- Safely dispose of packing materials such as screws, nails or batteries in a packing bag after installation or repair. Failure to do so may result in serious bodily injury.
- Do not install air conditioner with direct exposure to sea water or sea wind (salt spray) directly; because it may result in product failure.
- Install the drain hose properly for smooth drainage of condensed water. Failure to do so may result in product failure.
- Use caution when unpacking or installing the air conditioner. Failure to do so may result in bodily injury or product failure.
- When lifting or transporting the equipment, there should be 2 or more people, or a forklift. Failure to do so may result in bodily injury.
- Avoid exposure to leaking refrigerant which may occur during installation or repair. Failure to do so may result in personal injury and/or product failure.
- If there is a refrigerant leak during the installation of the air conditioner, ventilate the area immediately. Failure to do so may result in serious injury and/or product failure.

### Usage

#### **⚠ WARNING**

- Use only those parts which are listed in the service parts list. Never attempt to modify the equipment; because that may result in death, serious injury, and/or product failure.
- Discard the batteries in a safe manner and where there is no danger of excessive heat or fire. Failure to do so may result in explosion or fire.
- Contact an authorized service center when the air conditioner is submerged into water due to flooding. Failure to do so may result in explosion or fire.
- Only use components that are approved by the manufacturer and do not repair or modify them; because it may result in electric shock and/or product failure.
- Only use the refrigerant specified on the air conditioner label. Failure to do so may result in explosion or fire.
- Do not allow water to run into the air conditioner; because it may result in explosion or fire.
- Do not leave flammable substances such as gasoline, benzene and other white spirits or solvents, including thinner near the air conditioner; because it may result in explosion or fire and may result in bodily injury.
- Do not use the air conditioner for an extended period of time in a small place without ventilation; because it may result in explosion or fire. Make sure to ventilate the space regularly.
- Do not touch the electrostatic filter after opening the front grill; because it may result in electric shock or product failure.
- For inner cleaning, contact an Authorized Service Center or a dealer. Do not use harsh detergent that causes corrosion or damage on the unit; because it may cause product failure, fire, and/or electronic shock.
- Disconnect power if there is a noise, smell or smoke coming from the air conditioner. Failure to do so may result in explosion or fire.
- Ventilate room or area when air conditioner and a heating appliance such as a heater are used simultaneously. Failure to do so may result in fire, serious injury, and/or product failure.
- Make sure that children do not climb up the outdoor unit or impact it. Failure to do so may result in death, bodily injury and/or product failure.
- If there is a gas leak, ventilate area sufficiently before using the air conditioner again. Failure to do so may result in explosion or fire.
- Do not use the product for special purposes, such as preserving foods, works of art, etc.; because it may result in death, fire and/or electric shock. The product is a consumer air conditioner, not a precision refrigeration system.
- Do not block the inlet or outlet of air flow; because it may result in explosion or product failure.

# SAFETY INSTRUCTIONS

## Single Zone Art Cool Premier

---

---

### Usage (Continued)

#### **⚠ WARNING**

- Do not insert hands or other objects through the air inlet or outlet while the air conditioner is operating; because it may result in personal bodily injury or electric shock.
- Do not expose people, animals or plants to the cold or hot wind from the air conditioner; because it may result in serious injury.
- Do not drink the water drained from the air conditioner; because it may result in serious health complications.
- During maintenance, be sure to turn the main power off when cleaning or repairing the air conditioner. Failure to do so may result in death, serious bodily injury, and/or product failure.
- Remove the batteries when the remote control is not in use for an extended period of time. Failure to do so may result in product failure.
- Filter must be installed before operating the air conditioner. Failure to do so may result in product failure.
- Do not place any objects on the air conditioner; because it may result in product failure.
- Follow the standards of the corresponding region or country for handling the refrigerant and the air conditioner, and for disassembling the air conditioner. Failure to do so may result in product failure.
- Do not mix the batteries for the remote control with other types of batteries or mix new batteries with used batteries; because it may result in product failure.
- Do not recharge or disassemble the batteries; because it may result in explosion, fire or serious bodily injury.
- Do not dispose of the batteries in fire; because it may result in explosion or fire.
- Stop using the remote control if there is a battery fluid leak; and if your clothes or skin is exposed to the battery fluid from a leak, wash it off with clean water. Failure to do so may result in serious bodily injury.
- Do not let the air conditioner run for a long time when the humidity is very high or when a door or window has been left open; because it may result in product failure.

---

### Maintenance

#### **⚠ WARNING**



- Do not use strong cleaning agents or solvents when you clean the air conditioner, or spray water; because it may result in serious bodily injury or product failure. Make sure to use a smooth cloth when cleaning the product.
- Never touch the metal parts of the air conditioner when removing the air filter; because it may result in serious bodily injury or product failure.
- Use a sturdy stool or ladder when cleaning, maintaining or repairing the air conditioner at a height. Failure to do so may result in serious bodily injury or product failure.

# UNIT PARTS

## Single Zone Art Cool Premier

The following table shows the available outdoor and indoor units, their model numbers, along with the factory provided controller.

Table 1: Single Zone Art Cool Premier

Outdoor Unit Model/Btu/h	Indoor Unit Model/Btu/h	Controller
LAU090HYV / 9,000 LAU120HYV / 12,000 	LAN090HYV / 9,000 LAN120HYV / 12,000 	AKB73835312 

# UNIT OPERATION















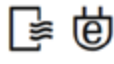















## Single Zone Art Cool Premier

## Remote Control

### Basic Remote Control Operation

The Single Zone Art Cool Premier comes equipped with a remote control, enabling convenient air conditioner operation. Table 2 below describes basic button functionality, along with the displayed icon/symbol that will appear on the screen. Figure 1 shows the display screen and placement of the buttons on the Remote Control.

Table 2: Remote Control Operation

Control Panel	Display Screen	Description
		<b>Air Circulation Button*</b> : Used to circulate the room air without cooling or heating.
 		<b>Auto Cleaning/Energy Saving Buttons*</b> : Sets time related to special functions such as automatic cleaning  and placing the unit into energy efficient cooling mode  .
	N/A	<b>On/Off Button</b> : Turns the remote controller power on/off.
 		<b>Temperature Adjustment Buttons</b> : Press up or down “arrow” temp buttons to adjust temperature during cooling or heating. Display screen will show adjusted temperature.
		<b>Operation Mode Selection Button</b> : Cycles through the operation mode, from top left symbols: Cooling mode:  Auto operation or auto changeover:  Dehumidifying mode:  Heating mode: 
		<b>Fan Speed Button</b> : Adjusts the indoor fan speed by pressing repeatedly. Also allows for natural air circulation (when wavy arrow is displayed)
		<b>Jet Button (Heating/Cooling)*</b> : Rapid heating or cooling of indoor temperature. Temperature heats or cools in a short period of time.
 		<b>Air Flow Direction (Swing) Buttons</b> : Adjusts the directions of air flow; vertically or horizontally through louvers.
 °C/°F(5SEC)		<b>Room Temperature Display Button</b> : Displays the current room temperature. Temperature value can be changed from °C or °F when button is pressed and held for 5 seconds.
		<b>Sleep Mode Auto Button*</b> : Pressing will activate sleep mode timer selection. Pressing the   allows you to select up to 7 hours prior to the unit automatically turning off.

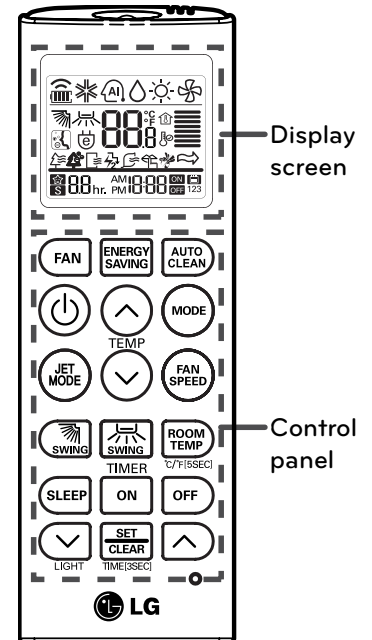
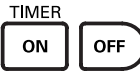
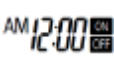











Figure 1: Art Cool Premier Remote Control - Model AKB73835312

\* Depending on the Single Zone Wall Mounted Model used, some functions may not be supported.



Table 2: Remote Control Operation (Continued)

Control Panel	Display Screen	Description
		<p><b>Timer Buttons (On/Off):</b> Sets the clock timer to enable automatic start and stop times for air conditioner activity.</p> <p>Pressing the   enables the user to set the actual time as shown on the display screen.</p>
		<p><b>Light Button:</b> Adjusts the brightness of the indoor unit display.</p>
	N/A	<p><b>Set/Clear Button:</b> Either sets (commits) a function or clears (cancels) a function.</p> <p>When pressing and holding for 3 seconds or longer, allows the user to set current time by using the   buttons.</p>
	N/A	<p><b>Up/Down (Directional) Buttons:</b> Used in conjunction with other primary mode and operation buttons. Once in desired mode, user can press the Up and Down button to move forward or backward in selections. For example these buttons can be used to set timer clock settings or brightness of the indoor unit display.</p>
	N/A	<p><b>Reset Button:</b> Pin reset indentation (shown under the “UP” button) allows the user to reset the air conditioner to factory defaults by inserting a pen tip or small screw driver into hole.</p>

# UNIT OPERATION

## Installing Batteries into Remote Control

1. Insert AAA batteries (1.5V) before turning on the remote.
2. Remove the battery cover from the back of the unit, by pushing down the tab at the top of the cover ((1) Figure 2).
3. Lift battery cover off of the unit as shown ((2) Figure 2).
4. Insert the batteries, following the + and - terminal indications inside the battery compartment. Make sure battery is securely in place (Figure 3).
5. Reattach the battery cover.

**Note:**

- If the display screen of the remote control starts to fade, replace the batteries.
- When batteries are removed, the temperature unit will be reset to Celsius as the default.

Figure 2: Remote Control Battery Cover

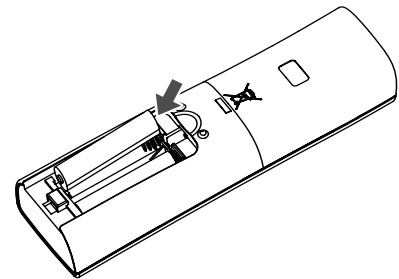
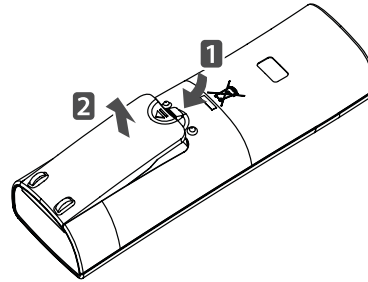

Figure 3: Battery Placement

## Installing the Remote Control Holder

**Note:**

Installation of the remote control holder should be out of direct sunlight, in order to protect the remote control from heat exposure.

1. Choose a safe and easily accessible place to attach the remote control holder.
2. Using a phillips head screwdriver, insert and fasten the 2 screws into the holes at the base (Figure 4).
3. Gently “wiggle” the base to make sure that it is firmly attached to the wall. Tighten the screws further if you feel the wall mount is still loose.
4. Slide the remote control vertically into the holder (Figure 5).

Figure 4: Holder Attachment

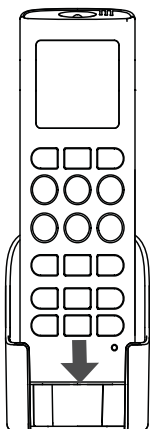
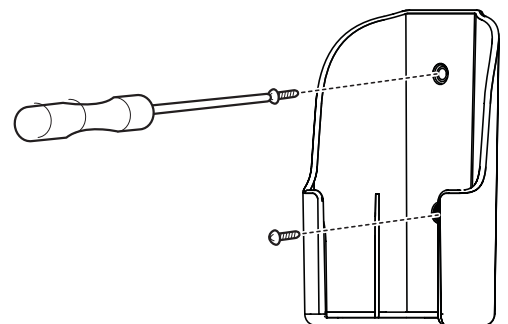

Figure 5: Insertion of Remote into Holder

### Initializing Operation of Remote Control

To begin communication between the indoor unit and the remote control, point the remote control towards the signal receiver, located at the bottom right hand corner of the indoor unit (see Figure 6).

**Note:**

- Make sure to point the remote control directly at the indoor unit, otherwise the remote might accidentally activate and operate other electronic devices due to the signal being picked up.
- For optimum operation, periodically use a soft cloth to wipe the signal transmitter on the remote control and the receiver on the indoor unit.
- Jet Mode in heating operation doesn't work when equipped with a wired remote controller.
- ON/OFF reserve mode doesn't work when equipped with a wired remote controller.

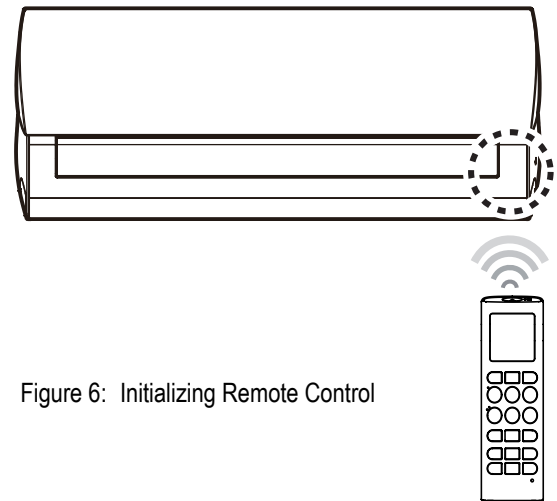
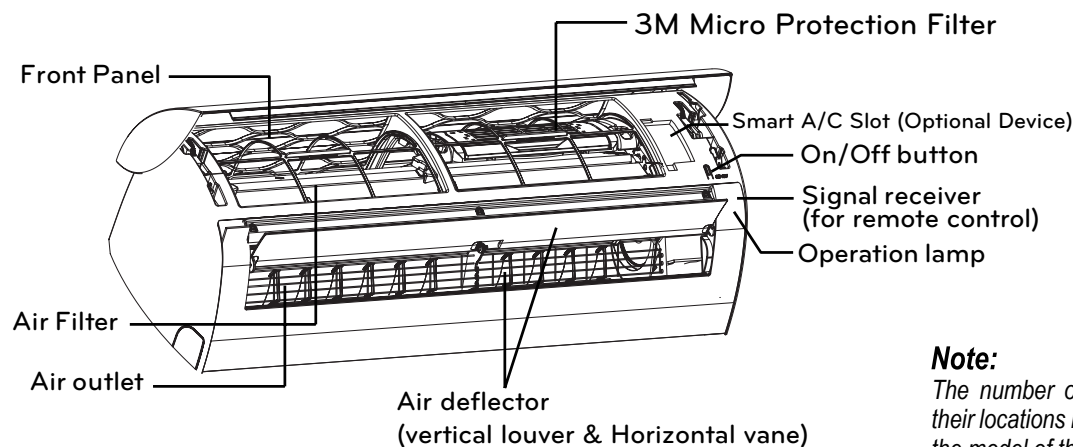

Figure 6: Initializing Remote Control

### Indoor Unit Basic Components

Refer to Figure 7 for the basic layout of the components of the Art Cool Premier indoor unit, when following operational, maintenance or troubleshooting instructions in this manual.



**Note:**





The number of operation lamps and their locations may vary, depending on the model of the indoor unit.

Figure 7: Art Cool Premier Indoor Unit Basic Components

# BASIC FUNCTIONS

## Cooling Operation - Adjusting the Air Flow (Swing) Direction

### Cooling Operation





1. On the Remote Control, press  to turn on the power to the indoor unit.
2. Press  repeatedly until the cooling symbol (snowflake)  is displayed on the Remote Control display screen.
3. Press the up and down arrow buttons   to increase or decrease currently displayed temperature.

**Note:**  
The temperature range for cooling is: 64.4 °F (18 °C) - 86 °F (30 °C).

### Air Circulation Operation

This mode only circulates the indoor air without changing the room temperature.

**Note:**  
The cooling lamp lights up in air circulation mode on the indoor unit.

1. On the Remote Control, press  to turn on the power to the indoor unit.
2. Press  to activate the air circulation operation.  will be displayed on the Remote Control display screen.
3. Press  to adjust the fan speed.

### Adjusting the Fan Speed













1. Press  repeatedly to adjust the fan speed. See Table 3 below for the various speed adjustments.
2. Select  if you want natural air. The fan speed adjusts automatically.

Table 3: Fan Speed Levels

Remark	Speed
	High
	Medium - High
	Medium
	Medium - Low
	Low
	Natural Wind

### Heating Operation



1. On the Remote Control, press  to turn on the power to the indoor unit.
2. Press  repeatedly until the heating symbol (sun)  is displayed on the Remote Control display screen.
3. Press the up and down arrow buttons   to increase or decrease the currently displayed temperature.

**Note:**

- The temperature range for heating is: 60.8 °F (16 °C) - 86 °F (30 °C).
- Cooling-only models do not support this function.

### Dehumidifying Operation





This mode removes excess moisture from an environment with high humidity or during local rainy seasons, in order to prevent mold from setting in. This mode adjusts the room temperature and the fan speed automatically to maintain the optimal level of humidity.

1. On the Remote Control, press  to turn on the power to the indoor unit.
2. Press  repeatedly until the dehumidifying symbol (raindrop)  is displayed on the Remote Control display screen.



**Note:**

- When indoor unit is in Dehumidifying Mode, you cannot adjust the room temperature. Temperature is being adjusted automatically.
- While in Dehumidifying Mode, display screen will not show the temperature value.

### Adjusting the Air Flow (Swing) Direction

1. To adjust the direction of the air flow vertically, press  repeatedly and select the desired position.
2. Select  on the Remote Control display screen, to adjust the desired vertical position automatically.
3. To adjust the direction of the air flow horizontally, press  repeatedly and select the desired position.
4. Select  on the Remote Control display screen, to adjust the desired horizontal position automatically.

**Note:**

- Some Single Zone Inverter Wall Mounted models may not support air flow direction. Check your model to be sure that it is an option.
- When restarting the air conditioner, it will remember the previously set direction of air flow. As a result, the air deflector may not accurately reflect the icon displayed on the Remote Control. If this occurs, press  or  to adjust the direction of the air flow once more.



### Setting the Timer

The Art Cool Premier unit can be programmed through timer settings to turn on and off at set times during the day and night. This functionality allows you to save energy and utilize the air conditioner more efficiently.

### Setting the Current Time

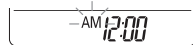
1. Press and hold  for longer than 3 seconds to initiate setting functionality.
  - The AM/PM icon will flicker at the bottom of the display screen.





2. Press one of the up and down buttons,   to scroll and then select the minutes (hours will scroll).
3. Press  when done to exit the setting mode.

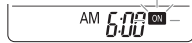

### Setting Air Conditioner On Time

1. Press the **On** button   under the Timer area of the Remote Control.
  - An "ON" icon will flicker to the right of the timer display on the display screen.





2. Press one of the up or down buttons   to select the minutes (hours will scroll).
3. Press  when done to exit the setting mode.

### Setting Air Conditioner Off Time

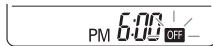



1. Press the **OFF** button   under the Timer area of the Remote Control.
  - An "OFF" icon will flicker to the right of the timer display on the display screen.



2. Press one of the up or down buttons   to select the minutes (hours will scroll).
3. Press  when done to exit the setting mode.

### Setting Sleep Mode

The Sleep Mode is used to turn off the air conditioner at a certain set time automatically so that you don't have to turn it off manually. It is a "countdown" timer and can be set for up to 7 hours ahead of the current time.

1. Press  to turn on the power.
2. Press **Sleep**  to initiate Sleep Mode settings.
3. Press one of the up or down buttons   to select the number of hours.
4. Press  when done to exit the setting mode.

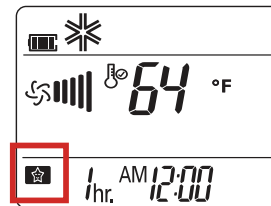

-  appears on the display screen to signify unit has been set to Sleep Mode.
- Your display screen might appear slightly different depending on your DFS Inverter model.



#### Note

- In the Cooling and Dehumidifying Modes, the temperature increases by 1.8 °F (1 °C) after 30 minutes and by a further 1.8 °F (1 °C) after another 30 minutes for a more comfortable sleep environment. The temperature increases up to 3.6 °F (2 °C) from the preset temperature.

### Cancelling Timer Settings

1. Press .
- To cancel all timer settings, press  once more.

# ADVANCED FUNCTIONS



## Jet Cool/Heat Operation - Auto Changeover Operation

Follow the operational directions in this section to work with advanced functionality and features of the Art Cool Premier Wall Mounted system.

### Jet Cool/Heat Operation

#### Rapid Cooling and Heating of Room Temperature

This functionality allows you to rapidly cool indoor air (during summer months) or warm indoor air (during winter months).

1. Press  to turn on the power.
2. Press the **Jet** button .
  - In Jet Cool Mode, unit operates at a setpoint of 64.4 °F (18 °C) for a duration of 30 minutes.
  - In Jet Heat Mode, unit operates at a setpoint of 86 °F (30 °C) for a duration of 30 minutes.



#### Note:

- Jet Cool/Heat Mode cannot be run during Air Circulation, Auto, or Auto Changeover Modes.
- This function may not be supported on all Single Zone Inverter models.

### Auto Clean Operation

#### Indoor Air Purification

While in cooling and dehumidifying mode, the air conditioner generates moisture on the interior of the indoor unit. The Auto Clean operation is used to remove this type of moisture.

1. Press  to start dehumidifying operation.
  -  is displayed on the Remote Control display screen.

#### Note:

- If the power is turned off, the fan will operate for 30 minutes and will clean the inside of the indoor unit.
- Some buttons (functionality) will not operate while the system is in Auto Cleaning Mode.

#### °C/°F Screen Display

The Single Zone Art Cool Premier unit can be set in either °C or °F temperature readout, by pressing and holding the Room Temperature button  for 5 seconds.







#### Note:

- This function may be not supported on all DFS Inverter models.

### Artificial Intelligence

#### Auto Operation - (Cooling Only Models)

During this functionality, the fan speed and the temperature adjust automatically, based on room temperature.

1. Press  to turn on the power.
2. Press the **Mode** button  repeatedly to select Auto operation  (see icon in Figure 8 below).
3. Press the up and down arrows   to select the desired numerical operation code for cooling/heating strength. See the table in Figure 8 below for a description of each numerical value.

#### Note:

- During the Artificial Intelligence Mode, you cannot adjust the fan speed.
- During this mode, you can set the air deflector to rotate automatically.
- This function may not be supported on all Single Zone Inverter models.



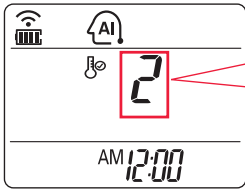



Figure 8: Auto Intelligence Screen with Code Description



Code	Description
2	Cool
1	Cool slightly
0	Maintain room temperature
-1	Heat slightly
-2	Heat

### Auto Changeover Operation

This functionality changes the operation mode automatically to maintain a set temperature of  $\pm 3.6$  °F ( $\pm 2$  °C).

1. Press  to turn on the power.
2. Press the **Mode** button  repeatedly to select Auto operation  (see icon display in red box in Figure 9 below).
3. Press the up and down arrows   to select the desired temperature.
  - The temperature range is 64.4 °F (18 °C) through 86 °F (30 °C).
4. Press  repeatedly as needed to adjust the fan speed.

#### Note:

- This function may not be supported on all Single Zone Inverter models.
- Your screen display may look slightly different depending on your DFS Inverter model.

Figure 9: Auto Changeover Display

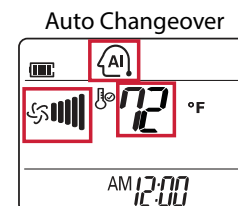





# ADVANCED FUNCTIONS

## Energy Saving Operation - Manual Operation

### Energy Saving Operation - Cooling

Placing the unit in this mode minimizes power consumption during cooling. It increases the set temperature to the optimal level for a more comfortable environment.

1. Press  to turn on the power.
2. Press  repeatedly until the cooling symbol (snowflake) ❄️ is displayed on the Remote Control display screen.
3. Press  to place unit into Energy Saving mode.
  -  appears on the display screen.

#### Note:

- During Energy Saving Mode, you could see a different temperature display between the actual indoor unit and the Remote Control display screen. This does not mean that the unit is malfunctioning in any way.
- This function may not be supported on all Single Zone Inverter models.

### Adjusting Display Screen Brightness

The indoor unit's screen can be adjusted for brightness.

- Press  repeatedly on the indoor unit to set the brightness to the desired level.

#### Note:

- This function may not be supported on all Single Zone Inverter models.

### Manual Operation of Air Conditioner

#### Operation Without Use of Remote Control

If the Remote Control is unavailable or inoperable (i.e., new batteries are called for), you can use the On/Off button located on the indoor wall unit (Inverter) to activate the air conditioner.

#### Note:

- The fan speed will be automatically set at High when manually operating the air conditioner from the wall unit.

#### Turning on the Air Conditioner - Manual Operation

1. Open the front panel of the DFS wall unit by lifting both sides of the cover slightly as shown in Figure 10.

Figure 10: Indoor Unit - Lift Front Panel

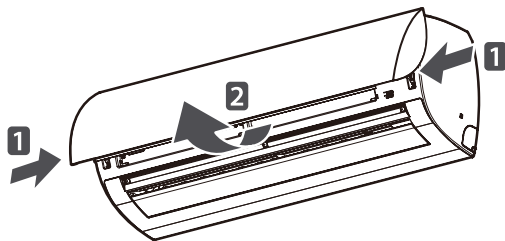

2. Press the On/Off button as shown in Figure 11.

#### Note:

- Your wall unit might appear slightly different depending on the DFS Inverter model.

Figure 11: On/Off Button Location on Indoor Unit

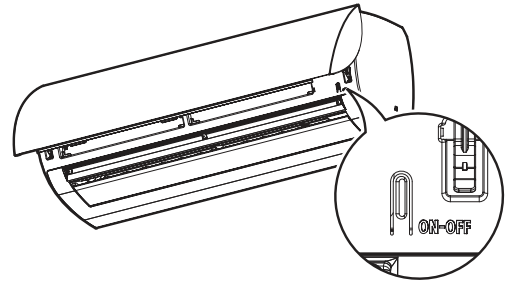

3. Immediately, close the front panel after pressing On/Off button as shown in Figure 12. Use both hands when closing the panel.

Figure 12: Close Front Panel of Indoor Unit

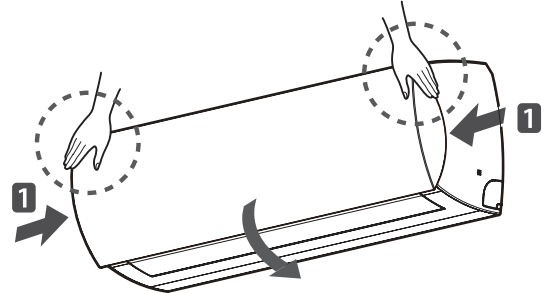

If your model is capable of both heating and cooling, the operation mode changes, depending on the room temperature. Refer to Table 4 below as to what the set temperature will be, based on your room temperature.

Table 4: Set Temperature

Room Temperature	Set Temperature	Operation Mode
Below 69.8 °F	75.2 °F	Heating Mode
Above 69.8 °F but below 75.2 °F	73.4 °F	Dehumidifying Operation
Above 75.2 °F	71.6 °F	Cooling Operation

#### Note:

For cooling only models, the temperature will be set at 71.6 °F.

# ADVANCED FUNCTIONS

## Manual Operation

### Turning on the Air Conditioner - Manual Operation

1. Close the front panel of the wall unit by lifting down both sides of the panel slightly, as shown in Figure 13. Use both hands when closing the panel.

Figure 13: Closing Front Panel of Wall Unit

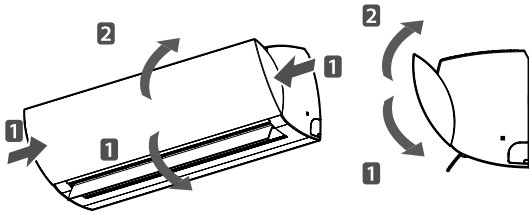

2. Next, open the front cover by lifting both sides of the cover slightly and then sliding up as show by #2 in Figure 14.

Figure 14: Opening Front Panel of Wall Unit

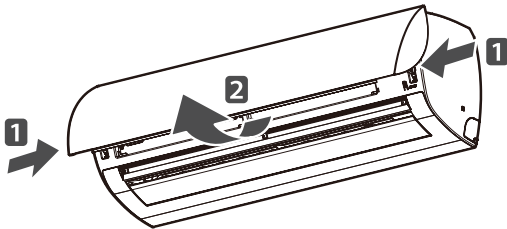

#### Note:

- Your screen display may look slightly different depending on your DFS Inverter model.

3. Press the On/Off button on the indoor wall unit (Figure 15).

Figure 15: On/Off Button on Wall Unit

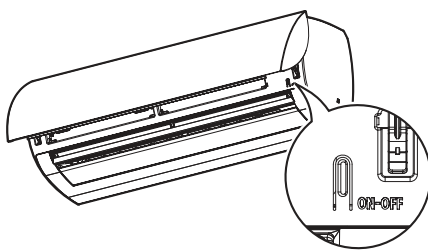

4. Immediately, close the front panel as soon as you press the On/Off button by pushing down both sides of the panel slightly (Figure 16).

Figure 16: Closing Front Panel of Wall Unit

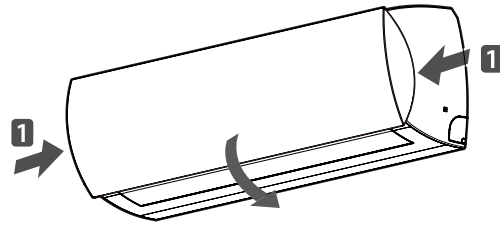

### Auto Restart Functionality

After a power failure, the unit can be programmed to automatically restart (reboot) and remember its previous settings. This function is a factory default setting. However, should you wish to disable the auto restart feature, follow the steps below.

#### Disable Auto Restart

1. Open the front cover of the indoor unit by lifting up both sides of the cover slightly (use two hands). Refer back to Figure 14.
  2. Press the On/Off button and hold it for 6 seconds. Refer back to Figure 15.
- The indoor unit will beep twice and the light will blink 6 times.
  - Unit will now be disabled for auto restart.

#### Re-enable Auto Restart

To re-enable the auto restart function, press the On/Off button and hold it for 6 seconds.

- The indoor unit will beep twice and the blue lamp will blink 4 times.
- The unit will now be enabled for auto restart.

#### Note:

- This function may not be supported on all Single Zone Inverter models.
- If you press and hold the On/Off button for 3-5 seconds, instead of 6 seconds (in other words, a shorter duration) the unit will be placed in test operation mode. In test operation mode, the unit blows out strong air for cooling, for 18 minutes, and then returns to the factory default settings.



# MAINTENANCE

## Indoor Unit - Cleaning Interval

Clean the product regularly to maintain optimal performance and to prevent possible breakdown. Refer to Figure 17 for filter placement. Refer to Table 5 for detailed instructions on maintenance. Review all safety instructions and warnings at the front of this manual; and adhere to all warnings and notes on this page before proceeding with maintenance.

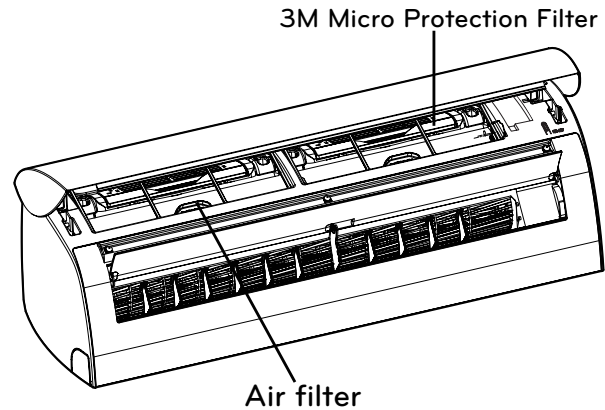

Figure 17: Art Cool Premier Indoor Filter Locations

### **⚠ WARNING**

#### **Maintenance Precautions**

- Turn off the power and unplug the cord before performing any maintenance to avoid electric shock.
- Never use water that is hotter than 104 °F (40 °C) when cleaning the filters. It may cause deformation (warping) or discoloration.
- Never use volatile substances when cleaning the filters. They may damage the surface of the product.
- Do not wash the 3M Micro Protection Filter with water. Filter may be damaged.

#### **Note:**

- The location and shape of the filter may differ in the Single Zone Inverter units, depending on the model.
- Be sure to clean the heat exchanger coils of the outdoor unit regularly. Dirt collected in the coils may decrease the operational efficiency or increase energy costs.

Table 5: Maintenance and Cleaning Interval Instructions

Item	Cleaning Interval	Cleaning Instructions
Air filter	Every 2 weeks	See "Air Filter - Cleaning/Maintenance" on page 18.
3M Micro Protection Filter	Monthly	• See "Cleaning the 3M Micro Protection Filter" on page 18.
Indoor unit surface	Regularly	• Use a soft, dry cloth. • Do not use bleach or abrasives.
Outdoor unit	Regularly, as needed	• Use steam to clean the heat exchanger coils and the panel vents. • If needed, consult with technician on proper care.

# MAINTENANCE

## Cleaning the Air Filter

### Cleaning 3M Micro Protection Filter

#### Air Filter - Cleaning/Maintenance

Clean the air filter located in the indoor unit, once every 2 weeks or more often as necessary. There are two filter screens on this unit.

**Note:**

Air filters differ from the 3M Micro Protection Filter in this unit. For cleaning the 3M Micro Filter see "3M Micro Protection Filter - Cleaning/Maintenance".

1. Turn off the power and unplug the power cord.
2. Open the front cover by lifting up both sides of the cover slightly (see #1 on Figure 18).

Figure 18: Lifting of Front Panel from Indoor Unit

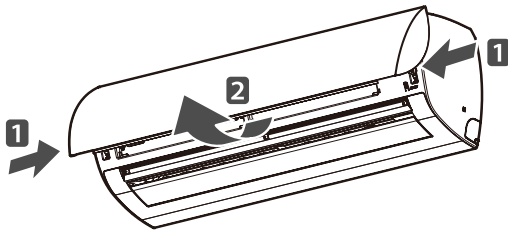

3. Grasp the knob/tab at the bottom the air filter, lift up slightly and slide it from the indoor unit.

Figure 19: Detaching Filter from Indoor Unit

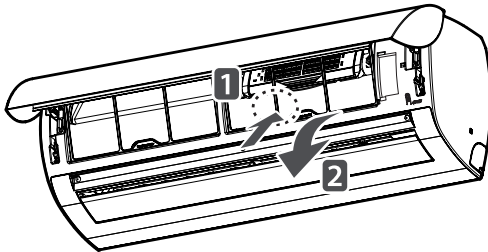

1. Clean the filter with a vacuum cleaner or with warm water.
  - If dirt is difficult to remove, wash the filter in lukewarm water with detergent.
2. Dry filter completely before placing back in the unit.
3. Replace the filter by sliding back into the unit and then while grasping the bottom knob/tab, lowering back into the unit.
4. Close the front panel of the indoor unit, by reversing the steps above.

#### ⚠ WARNING

- Use two hands when lifting the front panel away from the indoor unit.
- Maintain a grip on the front panel at all times while removing either air or 3M Micro Protection Filter.

#### 3M Micro Protection Filter - Cleaning/Maintenance

Clean the 3M Micro Protection Filter located in the indoor unit, once a month or more often as necessary. The 3M filter is located behind the indoor unit's right-hand side air filter (as looking at the unit from the front).

1. Turn off the power and unplug the power cord.
2. Open the front cover by lifting up both sides of the cover slightly (refer back to #1 on Figure 18).
3. Remove the right-side air filter as instructed in "Air Filter - Cleaning/Maintenance".
4. Remove the 3M Micro Protection Filter by popping it out of its holding tray within the unit (Figure 20).

Figure 20: Detaching 3M Micro Protection Filter from Indoor Unit

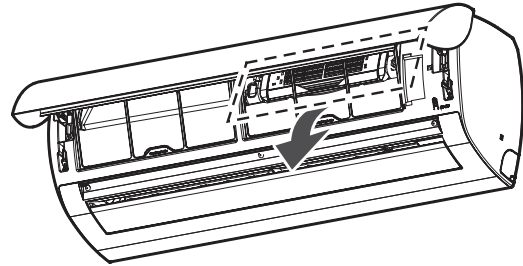

5. Use a vacuum cleaner to remove dirt from the filter.
6. Re-insert the 3M filter by reversing the steps above.

#### ⚠ WARNING

Do not wash the 3M Micro Protection Filter with water because the filter can be damaged.

**Note:**

- It is suggested to change the 3M Micro Protection Filter every 6 months.
- The location of the filter may differ, depending on the indoor unit model.
- To obtain more filters, contact your installing Contractor.

# TROUBLESHOOTING

## Single Zone Art Cool Premier

### Self-diagnosis Function

This product has a built-in self-diagnosis function. If an error occurs, the lamp of the indoor unit will blink in 2 second intervals. If this occurs, contact your local dealer or service center immediately for repair procedures.

Before requesting service refer to Table 6 in this section, regarding initial troubleshooting steps that can be taken. If the problem persists, contact your local service center.

### LG Customer Information

Contact LG Customer Information Center immediately if you see any issues as referred to in Table 6.

LG Customer Information Center	
<b>LG Electronics USA</b> 201 James Record Rd SW, Huntsville, AL 35824 888-865-3026	For USA calls: Press #2 for PTAC, TTW Press #3 for DFS, Multi V -- Call the installing contractor for your product, as warranty service will be provided by them. -- Call the USA number, if service issues have not been addressed by the contractor.
<b>LGECI</b> LG Electronics Canada Inc. 20 Norelco Drive North York, Ontario M9L 2X6 Canada  1-888-LG-CANADA (888-542-2623)	All service calls for CANADA.
<b>WWW.LG.COM</b>	Online registration of product

# TROUBLESHOOTING

## Single Zone Art Cool Premier

Table 6: Art Cool Premier Troubleshooting

Issue	Cause	Corrective Action
There is a burning smell and strange sound coming from the unit.	N/A	Immediately turn off the air conditioner. Contact your installing contractor.
Water leaks from the indoor unit even when the humidity level is low.		
The power cord is damaged or generating excessive heat.		
A switch, a circuit breaker (safety, ground) or a fuse is not operating properly.		
The air conditioner does not work.	A fuse has blown or the power supply is blocked.	Replace the fuse or check if the circuit breaker has tripped.
	A power failure has occurred.	Turn off the air conditioner when a power failure occurs. When the power is restored, wait 3 minutes, and then turn on the air conditioner.
	The voltage is too high or too low.	Check if the circuit breaker has tripped.
	The air conditioner turned off automatically at a preset time.	Press the power button again.
	Battery setting is wrong in the remote controller.	<ul style="list-style-type: none"> <li>• Check to see that battery is inserted with the correct terminals (+) and (-).</li> <li>• Replace with fresh batteries.</li> </ul>
The air conditioner does not generate cool air.	Air is not circulating properly.	Make sure that there are no curtains, blinds or furniture blocking the front of the air conditioner.
	The air filter is dirty.	Clean the air filter once every 2 weeks. See "Cleaning Air Filter" for more information.
	The room temperature is too high.	In summer, it may take some time to cool indoor air. In this case, select the jet cool operation to cool indoor air quickly.
	Cold air is escaping from the room.	Make sure that no cold air is escaping through ventilation points in the room.
	The desired temperature is higher than the set temperature.	Set the desired temperature to a level lower than the current temperature.
	There is a heating source nearby.	Avoid using a heat generator such as an electric oven or a gas burner while the air conditioner is in operation.
	Air circulation operation is selected.	In the air circulation operation, air blows from the air conditioner without cooling or heating the indoor air. Switch the operation mode to the cooling operation.
	Outside temperature is too high.	Air conditioner cooling capacity may not be sufficient to handle hot weather.

# TROUBLESHOOTING

## Single Zone Art Cool Premier

Table 6: Art Cool Premier Troubleshooting (Continued)

Issue	Cause	Corrective Action
The air conditioner does not generate warm air.	<ul style="list-style-type: none"> <li>When the heating mode is started.</li> <li>Vane is almost closed and air flow does not come out.</li> <li>Outdoor unit is operating but no warm air is generating.</li> </ul>	<p>This is normal operation of the unit. During start up, unit is preparing warm air.</p>
	Outdoor unit is in Defrost mode at the time.	<ul style="list-style-type: none"> <li>In heating mode, ice/frost is built up on the coils when the outside temperature falls.</li> <li>Defrost mode removes a layer of frost from the coil.</li> <li>Wait until this operation is completed. It takes about 15 minutes.</li> </ul>
	Outdoor temperature is too low.	Heating capacity of the unit may not be sufficient to effectively warm air.
The air conditioner stops during operation.	The air conditioner is suddenly turned off.	<ul style="list-style-type: none"> <li>Check to see if timer function has been set to turn off at designated time.</li> <li>Check timer settings and make adjustments as needed.</li> </ul>
	Power failure has occurred during air conditioner operation.	<ul style="list-style-type: none"> <li>Auto Restart is the default setting and is rebooting the system.</li> <li>If you experience frequent power failures, it is helpful to verify that system is set to Auto Restart so that the unit can re-power quickly.</li> </ul>
Air conditioner is still operating, even after being shut down.	<ul style="list-style-type: none"> <li>Auto Clean Mode is in operation.</li> <li>This function removes the rest of the moisture from the indoor unit.</li> </ul>	<ul style="list-style-type: none"> <li>Wait until the Auto Clean Mode has finished its function.</li> <li>You may turn this feature off.</li> </ul>
Mist is discharged from the air outlet of the indoor unit.	Cooled air from the indoor unit can form a mist.	If the room temperature is lowered the mist will stop forming.
Water leaks from the outdoor unit.	Cooled air from the air conditioner is forming mist.	<ul style="list-style-type: none"> <li>Install drain hose under the base pan.</li> <li>Contact the installer of the unit.</li> </ul>

# TROUBLESHOOTING

## Single Zone Art Cool Premier

Table 6: Art Cool Premier Troubleshooting (Continued)

Issue	Cause	Corrective Action
Unusual noise or vibration during operation of unit.	<ul style="list-style-type: none"> <li>Clicking noise during operation                             <ul style="list-style-type: none"> <li>Clicking sound can be heard either when the unit starts or stops due to movement of the reversing valve.</li> </ul> </li> <li>Creaking sound during operation                             <ul style="list-style-type: none"> <li>The plastic parts of the indoor unit make sounds due to shrinkage and expansion during sudden temperature shifts.</li> </ul> </li> <li>Water flowing sounds                             <ul style="list-style-type: none"> <li>Switching of the flow of refrigerant through the air conditioner produces water flowing noise.</li> </ul> </li> </ul>	These are normal noises for the air conditioner as it shifts into different modes of operation. Once mode is activated, noise or vibration should discontinue.
Unusual odor emits from indoor unit.	Bad odor can emit from the indoor unit due to mustiness or cigarette odor being taken in by the indoor unit from the room it is located in.	<ul style="list-style-type: none"> <li>If the smell does not disappear, clean air filter.</li> <li>Contact installer, if after cleaning air filter, odor still exists.</li> </ul>
<i>Troubleshooting Wired Remote Control PQRCSL0(QW)</i>		<i>Exclusively for North America (PREMTB10U)</i>
Directional buttons such as Up/Down or Left/Right, do not function when selected on Wired Remote Control.	If Air Conditioner Operation function is available (active), the Wired Remote Control will be able to change air conditioning/heating operational mode.	
Directional Swing buttons, do not display when selected on the Wired Remote Control.		
Cannot select power heating on indoor unit.		
Cannot set power heating on Wired Remote Control.	Not possible to set time for automatic on/off operation with the Wireless Remote Control or using the App software.	
The remaining time for the automatic On/Off timer is not shown on App software.		

This page intentionally left blank.

*Inverter*

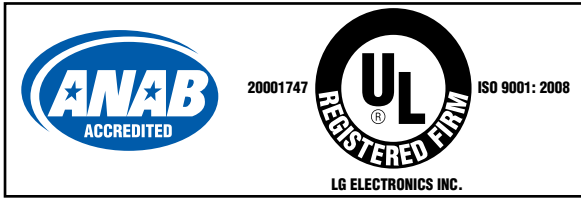

LG Electronics  
Commercial Air Conditioning Division  
11405 Old Roswell Road  
Alpharetta, Georgia 30009  
[www.lg-dfs.com](http://www.lg-dfs.com)

LG Electronics Commercial Products Support  
1-888-865-3026 USA  
Follow the prompts for commercial A/C products.